



TOOLS & ACCESSORIES CATALOG



version
3.0

Wood Stone

Changing the Way You Cook **since 1990**

Over 15,000 installations in 80+ countries worldwide.



	Welcome to Wood Stone	2
	Ordering Tools and Accessories	3
.....		
	Oven Tools	4
	Oven Accessories	8
	Oven Night Heat Retention Doors	10
.....		
	Tandoor Accessories	11
.....		
	Mt. St. Helens Accessories	12
.....		
	Rotisserie Accessories	14
	Whatcom Gas Vertical Rotisserie Accessories	17
.....		
	Solid Fuel Accessories	20



WELCOME TO
WOOD STONE

Wood Stone

Welcome to Wood Stone!

Wood Stone Corporation, based in Bellingham, Washington, has been manufacturing stone hearth and specialty commercial cooking equipment for the foodservice industry since 1990. We have more than 15,000 installations in over 80 countries worldwide.

Wood Stone built its reputation on our family of stone hearth ovens. Our technologically advanced ceramics and engineering expertise, coupled with our high quality construction techniques and attention to detail, are typical of all of our products and relied upon by our loyal customers. Our product offerings have grown since inception and Wood Stone now also designs, engineers and manufactures a line of specialty commercial cooking equipment in addition to our oven offerings.

Changing the Way You Cook since 1990

In 1989, challenged with the task of finding a wood-fired stone hearth oven or “brick oven” that could withstand the intense rigors of the restaurant world, Keith Carpenter set out for perfection. Inspired to create a better wood-fired oven, Carpenter pitched some ideas to Harry Hegarty, an experienced builder of large-scale, high-temperature ceramic incinerators. This meeting marked the beginning of an integral partnership, and by 1990, Wood Stone was born.

Just five years later in 1995, Wood Stone introduced gas-fired and gas-assist stone hearth ovens, with many different configurations to meet the breadth of commercial demands and most importantly, the needs of high-yield cook lines. Ever since, the value, versatility and production of our ovens have continued to grow, driven by high industry demands. With the large 2007 expansion of our manufacturing facility—including a dedicated research and development lab and a state-of-the-art integrated metal fabrication system—Wood Stone now spans over 117,000 square feet.

Additionally, our facility offers a full-service 1,500-square-foot Test Kitchen. Inside, our corporate chefs immerse visitors in all things Wood Stone, showcasing our unique recipes and enabling customers to try their hand using the ovens. Year round, the Bellingham Test Kitchen sees chefs from small “mom and pop” pizza parlors to corporate chain restaurants to hotels and educational institutions.

In January of 2014, Wood Stone was acquired by the Henny Penny Corporation, a global leader in foodservice equipment solutions and the inventor of the first commercial pressure fryer. Located in Eaton, Ohio, Henny Penny manufactures commercial-grade cooking, holding and merchandising equipment for thousands of restaurants, supermarkets and institutions around the world. Like Wood Stone, Henny Penny is a market leader and premier brand in the foodservice equipment industry.

Most recently on December 30, 2014, Henny Penny and Wood Stone became employee-owned (ESOP). This new chapter ensures our continuing success as privately held and independently operated companies. Together, we look forward to a bright future.

Throughout the years the mission of Wood Stone has been steadfast. Committed to quality, innovation and customer satisfaction, Wood Stone is here for you.

t. 360.650.1111
tf. 800.988.8103
f. 360.650.1166

Wood Stone Corporation
1801 W. Bakerview Rd.
Bellingham, WA 98226 USA
info@woodstone-corp.com
woodstone-corp.com

REVISED: SPRING 2017, r08

An ongoing program of product improvement may require us to change specifications without notice.

Wood Stone

Wood Stone recommends purchasing your complete equipment package from a Foodservice Equipment Dealer, including tools and accessories. We want to ensure that you are choosing the right tool or accessory for your particular application. If you are not already working with a dealer, please contact the Wood Stone representative in your area by visiting us online at woodstone-corp.com/contact or by calling us at 800.988.8103.

For added convenience, customers can shop for replacement oven tools by visiting "Shop Tools & Accessories" online at woodstone-corp.com.

For service-related replacement parts, please call the Wood Stone Service Department at 800.988.8103.



t. 360.650.1111
tf. 800.988.8103
f. 360.650.1166

Wood Stone Corporation
1801 W. Bakerview Rd.
Bellingham, WA 98226 USA
info@woodstone-corp.com
woodstone-corp.com

REVISED: SPRING 2017

An ongoing program of product improvement may require us to change specifications without notice.



Wood Stone tools are designed for efficient kitchen operation, and to help you get the most out of your oven. With a few exceptions, most tools feature heavy-duty stainless steel handles and grease-resistant grips—built for years of dependable service.

A. LOADING PEELS WS-TL-LP-(S, M, L or XL)

These lightweight aluminum alloy Loading Peels come in five sizes that are perfect for up to 12", 14", 16" and 18" pizzas. A 13" loading peel is available in stainless steel.

B. NATURAL FIBER BRUSH

WS-TL-NFB-(S, M, L or XL)

For general sweeping, we offer a Natural Fiber Brush. The short and medium lengths have wood handles (pictured below). The long and extra long lengths have stainless steel handles and replaceable heads.

C. IN-LINE BRASS-BRISTLED BRUSH

WS-TL-IFB-(S, M, L or XL)

The heavy-duty In-Line Brush features a 10" wood head, beveled to facilitate debris removal from all corners of the oven. In-Line brush heads are replaceable.

D. T-STYLE BRASS-BRISTLED BRUSH

WS-TL-TFB-(S, M, L or XL)

E. T-STYLE NATURAL FIBER BRUSH

WS-TL-TNFB-(S, M, L or XL)

The heavy-duty T-Style Brush features a 10" wood head, beveled to facilitate debris removal from all corners of the oven. T-Style brush heads are replaceable.

F. BUBBLE HOOK WS-TL-BH-(S, M, L or XL)

The Bubble Hook is for popping pizza dough bubbles before they get out of hand. Made from heavy gauge stainless steel, it is also great for moving pans, trays and even wood.

G. UTILITY PEEL WS-TL-UP-(S, M, L or XL)

Move or rotate any size pizza with nearly surgical precision with Wood Stone's Utility Peel. The 8-inch diameter utility peel is also very useful for moving pans, placing wood on the fire and removing ash. Select lengths available in either stainless steel or titanium versions.

H. PARTICLE SHOVEL WS-TL-PS-(S, M, L or XL)

Our heavy gauge stainless steel Particle Shovel is designed to safely remove ash and coals from wood-fired ovens and charbroilers. The head and handle are welded to ensure durability. Its front is beveled to remove ash from even hard-to-reach corners.

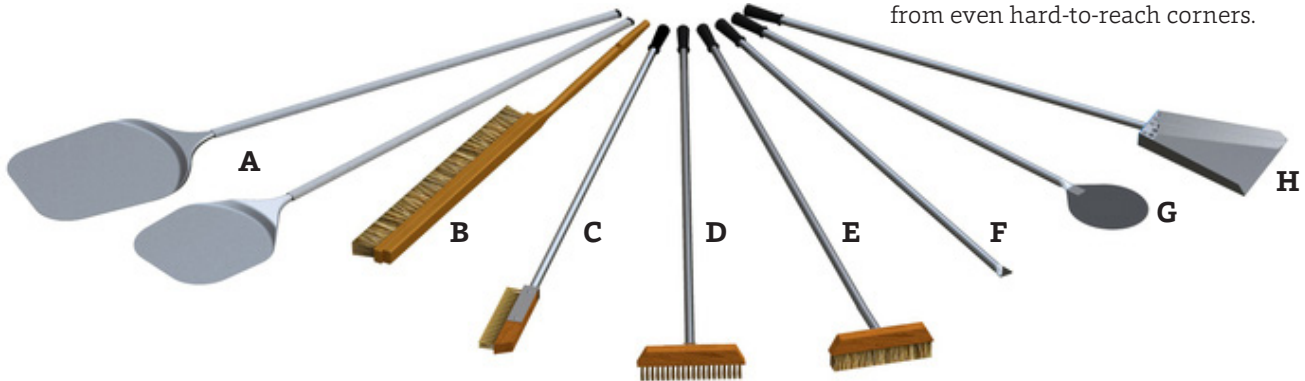

WHAT LENGTH IS RIGHT FOR YOUR OVEN?	Oven Model	Short (S)	Medium (M)	Long (L)	X-Long (XL)
	Bistro Line	3030, 4343, 4836	4355		
	Mountain Series	Mt. Chuckanut 4'	Mt. Adams 5'	Mt. Baker 6'	Mt. Rainier 7'
	Fire Deck Series		6045, 8645, 9660, 11260	11275	9690, 11290, 90-112
	Traditional Series		5'	6'	
	Designer Series		6348, 7248		

t. 360.650.1111
tf. 800.988.8103
f. 360.650.1166

Wood Stone Corporation
1801 W. Bakerview Rd.
Bellingham, WA 98226 USA
info@woodstone-corp.com
woodstone-corp.com

REVISED: SPRING 2017, r02

An ongoing program of product improvement may require us to change specifications without notice.





Brush Sets	Item #	Nat'l Fiber	In-Line Brush	T-Style Brush
Short Brush Set	WS-TL-BS-S	36"	40"	40"
Medium Brush Set	WS-TL-BS-M	51"	60"	60"
Long Brush Set	WS-TL-BS-L	70"	70"	70"
Extra Long Brush Set	WS-TL-BS-XL	87"	87"	87"

Gas-Fired Oven Tool Sets	Item #	12" Loading Peel	16" Loading Peel	Nat'l Fiber Brush	In-Line Brush	T-Style Brush	Bubble Hook	Utility Peel S/S
Short Gas Tool Set	WS-TL-SET-S-GAS	32"	N/A	36"	40"	40"	40"	40"
Medium Gas Tool Set	WS-TL-SET-M-GAS	50"	50"	51"	60"	60"	60"	60"
Long Gas Tool Set	WS-TL-SET-L-GAS	60"	60"	70"	70"	70"	70"	70"
Extra Long Gas Tool Set	WS-TL-SET-XL-GAS	87"	87"	87"	87"	87"	87"	87"

Wood-Fired Oven Tool Sets	Item #	12" Loading Peel	16" Loading Peel	Nat'l Fiber Brush	In-Line Brush	T-Style Brush	Bubble Hook	Utility Peel S/S	Particle Shovel
Short Wood Tool Set	WS-TL-SET-S-W	32"	N/A	36"	40"	40"	40"	40"	40"
Medium Wood Tool Set	WS-TL-SET-M-W	50"	50"	51"	60"	60"	60"	60"	60"
Long Wood Tool Set	WS-TL-SET-L-W	60"	60"	70"	70"	70"	70"	70"	70"
Extra Long Wood Tool Set	WS-TL-SET-XL-W	87"	87"	87"	87"	87"	87"	87"	87"

Key	Individual Tools	Part #	Short (-S)	Medium (-M)	Long (-L)	X-Long (-XL)
A	12" Loading Peel	WS-TL-LP-12-*	32"	50"	60"	87"
A	13" Loading Peel †	WS-TL-LP-13-*	32"	50"	60"	87"
A	14" Loading Peel	WS-TL-LP-14-*	32"	50"	60"	87"
A	16" Loading Peel	WS-TL-LP-16-*	N/A	50"	60"	87"
A	18" Loading Peel	WS-TL-LP-18-*	N/A	50"	60"	87"
B	Natural Fiber Brush ††	WS-TL-NFB-*	36"	51"	70"	87"
C	In-Line Brass-Bristled Brush	WS-TL-IFB-*	40"	60"	70"	87"
D	T-Style Brass-Bristled Brush	WS-TL-TFB-*	40"	60"	70"	87"
E	T-Style Natural Fiber Brush	WS-TL-TNFB-*	40"	60"	70"	87"
F	Bubble Hook	WS-TL-BH-*	40"	60"	70"	87"
G	Utility Peel-Stainless	WS-TL-UP-*	40"	60"	70"	87"
G	Utility Peel-Titanium	WS-TL-UP-T-*	40"	60"	70"	N/A
H	Particle Shovel	WS-TL-PS-*	40"	60"	70"	87"

*Complete the part number with the length character code, either S, M, L or XL.

†13" Loading Peel is stainless steel. All other peels are aluminum.

††Short & Medium lengths have wood handles; Long and Extra Long have stainless steel handles and heads are replaceable.

t. 360.650.1111
 tf. 800.988.8103
 f. 360.650.1166

Wood Stone Corporation
 1801 W. Bakerview Rd.
 Bellingham, WA 98226 USA
info@woodstone-corp.com
woodstone-corp.com

REVISED: SPRING 2017, r02

An ongoing program of product improvement may require us to change specifications without notice.



Wood Stone tools shown have heavy-duty stainless handles and grease-resistant grips.

A. SCRAPER TOOL

The Scraper Tool is useful for scraping the deck floor and removing heavy, baked-on debris and buildup. A stainless steel handle, grease-resistant grip and angled head provide plenty of leverage, even in the rear of the oven.

WS-TL-S-60 Small/Medium Handle, 60"

WS-TL-S-70 Long Handle, 70"

WS-TL-S-80 Extra Long Handle, 80"

B. PITA PEEL WS-TL-PP-63

The 63" basket-style Pita Peel is designed for scooping up multiple pitas, finishing them in the dome (without overheating) and removing them. No other tool can perform these functions as well. The handle is stainless steel, and the basket is sturdy, lightweight aluminum.

C. FLOOR TOUCH-UP TOOL WS-TL-TU

The 67" Floor Touch-Up Tool provides a means to smooth minor surface irregularities on the oven deck, especially when a slightly uneven surface has developed due to a crack in the oven deck.

D. WOK

This stainless steel Wok with stainless steel handle and grease-resistant grip adds versatility and stir-fry capabilities to a Wood Stone oven. Place the Wok next to the gas burner or wood fire, preheat, and start sizzling.

WS-TL-WOK-S Short Handle, 40"

WS-TL-WOK-M Medium Handle, 60"

WS-TL-WOK-L Long Handle, 70"

WS-TL-WOK-XL Extra Long Handle, 87"

E. COAL OVEN RAKE

The triangular hoe-style Coal Oven Rake is useful in coal-fired ovens for manipulating coal inside the oven chamber, as well as scraping debris and fly ash through the coal grates and into the ash chute.

Available in two lengths:

WS-TL-CR-M Medium Handle, 63"

WS-TL-CR-XL Extra Long Handle, 84"

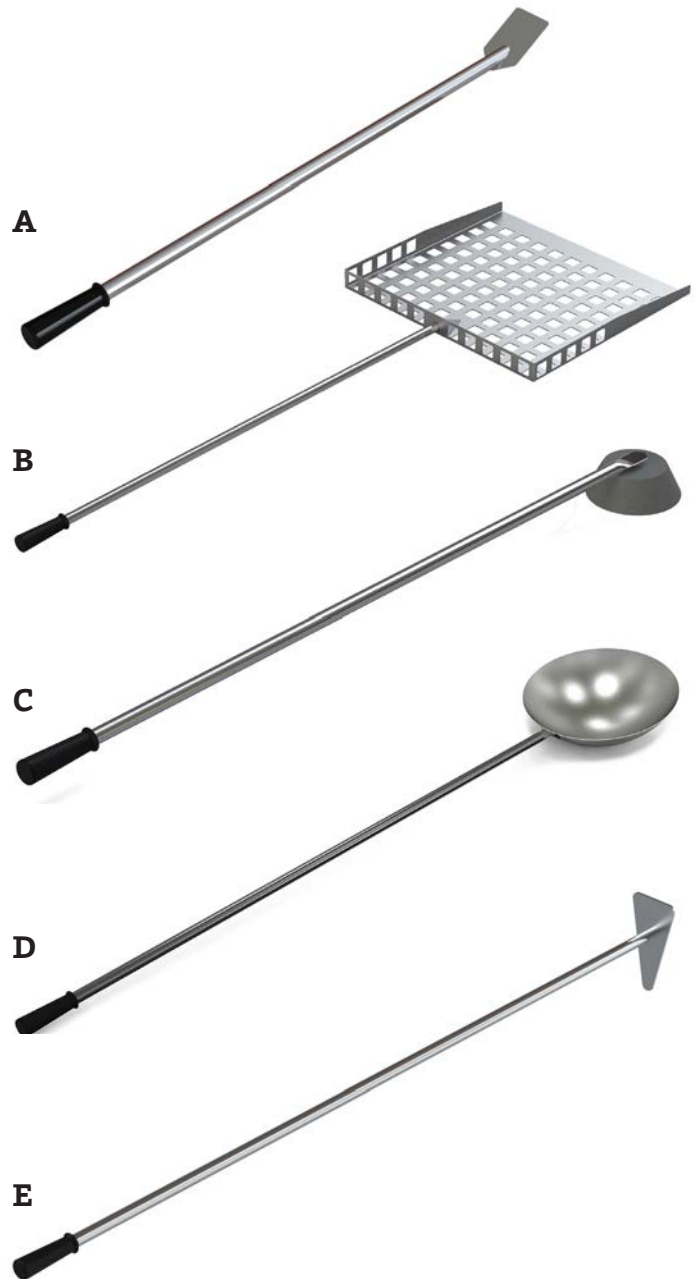

t. 360.650.1111
tf. 800.988.8103
f. 360.650.1166

Wood Stone Corporation
1801 W. Bakerview Rd.
Bellingham, WA 98226 USA
info@woodstone-corp.com
woodstone-corp.com

REVISED: SPRING 2017, r02

An ongoing program of product improvement may require us to change specifications without notice.

Wood Stone



F. DETACHABLE PEEL HANDLE WS-TL-DPH

The 38" stainless steel Detachable Peel Handle has been designed to securely attach and quickly release Detachable Peel Heads (3000-0058). When the peel head is inserted into the catch, the latch automatically locks it in place. Peels are removed by pressing the latch.

G. DETACHABLE PEEL HEAD 3000-0058

These 18 x 26" wood Detachable Peel Heads with 7" handle (minimum order of 6) have been designed to securely attach and quickly release using the Detachable Peel Handle (WS-TL-DPH, sold separately). Pizzas built on detachable peels are ready for immediate baking or can be pre-staged, ready for the rush!

H. IN-LINE OR T-STYLE BRASS-BRISTLED BRUSH REPLACEMENT HEAD 3000-0002

Replacement Head for both In-Line and T-Style Brass-Bristled Brushes. By orienting the 10" brush head differently, the same head works for both styles of brush. Minimum order of two.

I. T-STYLE NATURAL FIBER BRUSH REPLACEMENT HEAD 3000-0060

Replacement Head for the T-Style Natural Fiber Brush. Minimum order of two.

J. NATURAL FIBER BRUSH REPLACEMENT HEAD 3000-0037

Replacement Head for the Long and Extra Long Natural Fiber Brush. Minimum order of two.

Note: Short and Medium lengths are single piece construction, so the head alone is not replaceable.

K. TOOL GRIP 3000-0005

Replacement grease-resistant Tool Grip for any stainless steel handled Wood Stone oven tool. Minimum order of two.

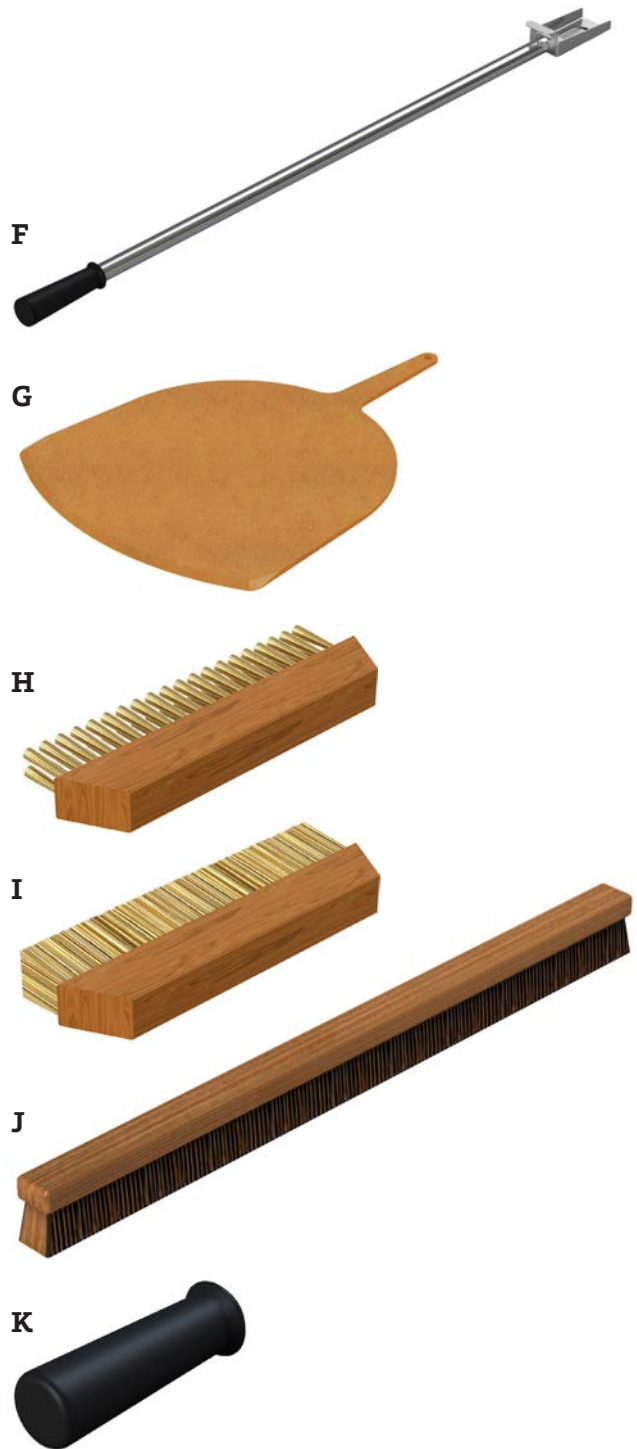

t. 360.650.1111
 tf. 800.988.8103
 f. 360.650.1166

Wood Stone Corporation
 1801 W. Bakerview Rd.
 Bellingham, WA 98226 USA
info@woodstone-corp.com
woodstone-corp.com

REVISED: SPRING 2017, r02

An ongoing program of product improvement may require us to change specifications without notice.



A. HIGH-TEMP CERAMIC BAKING SLATE

The heart of a Wood Stone oven is now available for your conventional rack or convection oven—Baking Slates manufactured from the same ceramic used in the construction of our stone hearth ovens. The slates are cast into standard sheet pans so they are conveniently sized at 18 x 26", weighing 44 lbs (full sheet) and 18 x 13", weighing 18 lbs (half sheet).

In addition to enhancing the crust properties of pizza and bread products, the high-temperature Ceramic Baking Slate will help the oven hold on to valuable heat that is normally lost every time the door is opened.

WS-SLATE-1826 (full sheet)

WS-SLATE-1813 (half sheet)

A



B. HAND HELD IR THERMOMETER WS-TL-IRT

This easy-to-use device allows instant surface temperature measurements anywhere in your Wood Stone oven. Just point the Hand Held IR Thermometer at the surface in question and press the button—the temperature is instantly displayed on an LCD readout. The button can be held down for scanning surfaces. The meter takes a reading every half second and has accuracy of ±3 °F and a range of 0–750 °F. It is powered by one 9V battery and is built of high-impact plastic for long life.

B



C. SPARE PARTS KIT

Since Wood Stone Ovens anchor most cooklines, the Spare Parts Kit can play an important supporting role minimizing down time. The sturdy metal 6 x 6 x 4 inch deep box conveniently stores underneath the oven, containing a Gas Control Smart Valve, a Pilot Igniter and a Pilot Igniter Gasket. These common replacement parts are appropriate for all Wood Stone oven models (specify gas type when ordering). For less than the cost of an extended warranty, the Spare Parts Kit saves the time and expense of a second service call after waiting for parts.

RP-0020-NG (Natural Gas models)

RP-0020-LP (Liquid Propane models)

C



Pilot Igniter Assembly



Gas Control Smart Valve



Radiant Pilot Gasket

REVISED: SPRING 2017, r03

An ongoing program of product improvement may require us to change specifications without notice.

t. 360.650.1111
tf. 800.988.8103
f. 360.650.1166

Wood Stone Corporation
1801 W. Bakerview Rd.
Bellingham, WA 98226 USA
info@woodstone-corp.com
woodstone-corp.com





C. SMOKER BOX 000-313

Wood Stone's Smoker Box uses wood chips to give the aroma of a wood-fired oven in a gas-fired oven. Constructed of heavy-duty stainless steel for years of service. The box is 9.5" long x 4.25" wide x 2" deep.

D. OVEN TOOL HANGER 1650118

Wood Stone's Oven Tool Hanger offers a convenient way to have your tools easily accessible while cooking. The hanger is 2.5" wide x 3.5" deep. Minimum order of two.

E. LOADING PEEL TOOL HANGER

3000-0054

The Loading Peel Tool Hanger is specifically designed to accommodate all loading peels. The hanger is 4.5" wide x 1.625" deep. Minimum order of two.

F. MANTLE CRUMB TRAY 000-CRUMB-TRAY-01

The Mantle Crumb Tray is a receptacle which hangs on pegs and collects debris brushed into it. Removal, emptying and replacement is easy. It can be retrofitted onto any Fire Deck oven mantle. The Mantle Crumb Tray for all Fire Deck Series models (except the FD-6045) is 57.5" long x 2" wide x 1.75" deep. Please call for details on the FD-6045 tray.

C



D

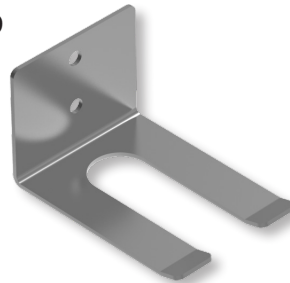

E



F

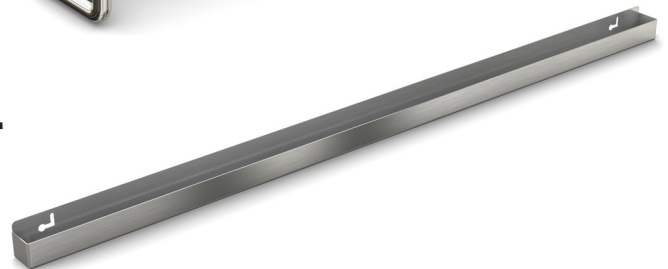

Oven Tool Hanger and Loading Peel Tool Hanger in use at Devon Energy Headquarters, Oklahoma City, OK.

t. 360.650.1111
tf. 800.988.8103
f. 360.650.1166

Wood Stone Corporation
1801 W. Bakerview Rd.
Bellingham, WA 98226 USA
info@woodstone-corp.com
woodstone-corp.com

REVISED: SPRING 2017, r03

An ongoing program of product improvement may require us to change specifications without notice.



OVEN NIGHT HEAT RETENTION DOORS

WoodStone

NIGHT HEAT RETENTION DOORS

Conserve the heat of your oven overnight using Night Heat Retention Doors. They are constructed of stainless steel, with spring handles. **Note:** These doors should not be used when the oven is turned on.

A. BISTRO LINE OVENS

000-3030-ND (for Model WS-BL-3030)

000-4343-ND (for Models WS-BL-4343, BL-4355, BL-4836)

B. MOUNTAIN SERIES OVENS

000-4-ND (for Model WS-MS-4)

000-5-ND-SET (for Model WS-MS-5)*

000-6-ND-SET (for Model WS-MS-6)*

000-7-ND-SET (for Model WS-MS-7)*

C. FIRE DECK SERIES OVENS

000-9660-ND-SET (for Models WS-FD-9660, FD-11260)*

000-9690-ND-SET (for Models WS-FD-9690, FD-11275,
FD-11290)*

000-90112-ND-SET (for Model WS-CS-90-112)*

*Item consists of a two-door set

A



000-4343-ND shown.

B

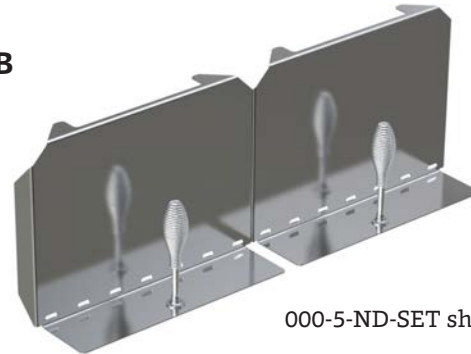

000-5-ND-SET shown.

C

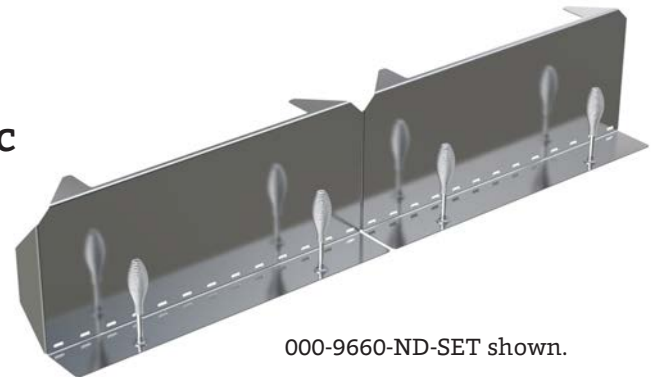

000-9660-ND-SET shown.

t. 360.650.1111
tf. 800.988.8103
f. 360.650.1166

Wood Stone Corporation
1801 W. Bakerview Rd.
Bellingham, WA 98226 USA
info@woodstone-corp.com
woodstone-corp.com

REVISED: SPRING 2017

An ongoing program of product improvement may require us to change specifications without notice.

WoodStone



A. TANDOOR NAAN HOOK WS-TL-SK-HOOK

The 37" Tandoor Naan Hook is used in conjunction with the Tandoor Naan Scraper for the traditional preparation of Naan bread, allowing efficient removal of multiple loaves. This handcrafted stainless steel tool is built to last.

B. TANDOOR NAAN SCRAPER WS-TL-SK-SCRAPER

The 37" Tandoor Naan Scraper is used in conjunction with the Tandoor Naan Hook to remove Naan bread in the traditional method. Handcrafted by Wood Stone.

C. TANDOOR SKEWER (SEEKH) WS-TL-SK

The 37" Tandoor Skewer is designed for vegetables and proteins. The stainless steel skewer includes one Keeper Clip (000-318-CLIP).

D. TANDOOR NAANDLE WS-TL-NAANDLE

The 34" Tandoor Naandle replicates a traditional Naan pillow. The pillow covers a spring-loaded aluminum plate with a stainless steel handle and grease-resistant grip to allow for easy application of the Naan bread to the interior walls of the Tandoor.

E. TANDOOR 9" CANVAS COVER & PAD 3000-0017

Replacement Canvas Cover & Pad for the Tandoor Naandle.

F. TANDOOR SKEWER INDEXING RING

The Tandoor Skewer Indexing Ring, standard with new Tandoors, sits atop the opening to support skewers. Replacements available for both 31" and 35" models.

1650810 (for 31" Tandoor)

1650809 (for 35" Tandoor)

G. TOOL SET FOR TANDOOR WS-TL-SET-TANDOOR

The Tool Set For Tandoor includes one Tandoor Naan Hook (WS-TL-SK-HOOK), one Tandoor Naan Scraper (WS-TK-SK-SCRAPER) and 10 Tandoor Skewers (WS-TL-SK).

H. SAUCE PAN RACK 000-402-57

A stainless steel shelf with cutouts for a 1/9th pan, a 1/6th pan and a 2.5 qt. round pan (pans/lids included) which hang from posts on either side of the square Tandoor.

I. STAINLESS STEEL SHELF 000-401-57

A high quality, stainless steel work shelf which hangs from posts on either side of the square Tandoor.

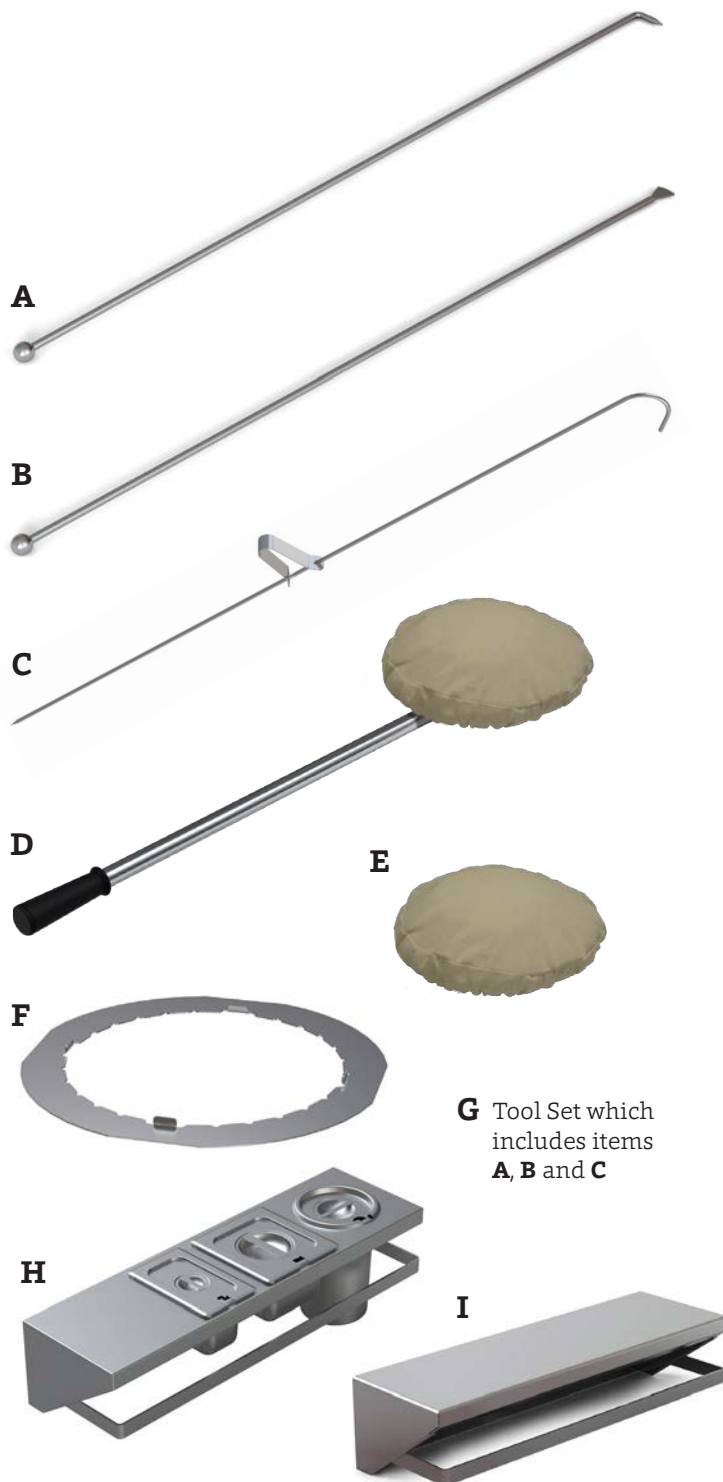

G Tool Set which includes items **A, B** and **C**

t. 360.650.1111
tf. 800.988.8103
f. 360.650.1166

Wood Stone Corporation
1801 W. Bakerview Rd.
Bellingham, WA 98226 USA
info@woodstone-corp.com
woodstone-corp.com

REVISED: SPRING 2017, r02

An ongoing program of product improvement may require us to change specifications without notice.



A. BROILER SHELF

000-BROILER-SHELF-(34, 45, 54, 57 or 72)

Adjustable stainless steel Broiler Shelf with Wire Cooking Racks for grilling, roasting or smoking. Not available with rotisserie-equipped units. In 34", 45", 54", 57" or 72" widths.

B. SKEWER (SATAY) RACK

SKEWER-RACK-(34, 45, 54, 57 or 72)

Stainless steel Skewer (Satay) Rack perfect for satay, kabobs or skewers. In 34", 45", 54", 57" or 72" widths.

C. SAUCE PAN RACK 000-402-(29, 34, 45 or 57)

A high quality, stainless steel shelf with cutouts for one 1/9th pan (except -34), one 1/6th pan, and one 2.5 qt. round pan (pans with lids included). **Note:** One (-45) rack can be mounted on either side, and two racks will fit on the front of all charbroiler models, except the SFB-5426.

Two (-29) racks can fit on the front of the SFB-5426.

Three (-45) pan racks can fit on the front of the SFB-72.

D. STAINLESS STEEL SHELF

000-401-(29, 34, 45 or 57)

A high quality, stainless steel work shelf with an under-slung utensil rail for hanging tongs or other grill tools.

Note: One (-45) Stainless Steel Shelf can be mounted on either side, and two shelves will fit on the front of all charbroiler models, except the SFB-5426.

Two (-29) shelves can fit on the front of the SFB-5426.

Three (-45) shelves can fit on the SFB-72.

E. GRATE TOOL WS-TL-GT

A durable, stainless steel tool with a hook for moving grill grates, the Grate Tool is also useful for manipulating the firebox and wood inside of the charbroiler.

F. PARTICLE SHOVEL WS-TL-PS-S

Our 40" heavy gauge stainless steel Particle Shovel is designed to safely remove ash and coals from the Mt. St. Helens Charbroiler. Its front is beveled to remove ash from even hard-to-reach corners.

G. T-STYLE BRASS-BRISTLED BRUSH

WS-TL-TFB-S

The 40" T-Style Brass-Bristled Brush is used to brush off Broiler Grates. Replacement Heads are available (see pg 7).



SFB-57 shown.

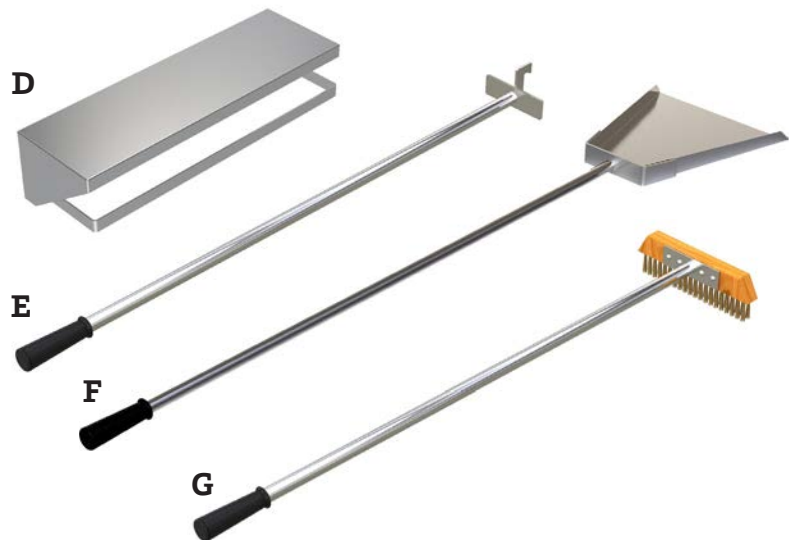
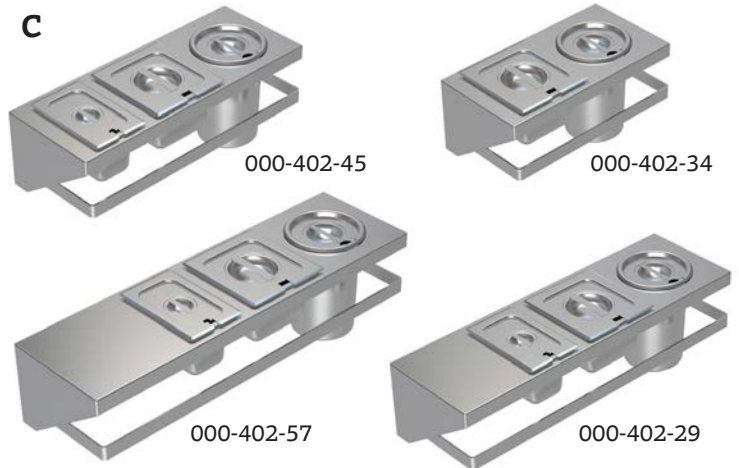

REVISED: SPRING 2017

An ongoing program of product improvement may require us to change specifications without notice.

t. 360.650.1111
tf. 800.988.8103
f. 360.650.1166

Wood Stone Corporation
1801 W. Bakerview Rd.
Bellingham, WA 98226 USA
info@woodstone-corp.com
woodstone-corp.com





A. STANDARD BROILER GRATE 50RO-0017

Replacement 6 x 24" Standard Broiler Grate for the 34", 45", 57" and 72" Mt. St. Helens Charbroiler. **Note:** Two grates on the 72" model are 4 x 24" grates (50RO-0017-1). See table below.

B. MODEL 5426 BROILER GRATE 50RO-0017-2

Replacement 6 x 16" broiler grate for model SFB-5426 of the Mt. St. Helens Charbroiler. See table below.

C. BROILER GRATE NARROW 50RO-0017-1

Replacement 4 x 24" broiler grate for the 72" model. **Note:** The 72" model also utilizes 6 x 24" Standard Broiler Grates (50RO-0017). See table below.

Model	6 x 24" Grates (A)	6 x 16" Grates (B)	4 x 24" Grates (C)
SFB-34	5		
SFB-45	7		
SFB-57	9		
SFB-72	10		2
SFB-5426		8	

Countertop model grate requirements are identical.

D. BROILER SHELF WIRE COOKING RACKS

000-404

Replacement 10 x 10.75" wire cooking racks for the Broiler Shelf.

SFB-34 (6 racks total)

SFB-45 (8 racks total)

SFB-5426, SFB-57 (10 racks total)

E. SEARING PLATE 000-SEARING-PLATE

Replace a 6 x 24" Standard Broiler Grate with a Searing Plate to sear scallops, sauté chopped veggies or even make pancakes! Made of polished mild steel. Not available for the SFB-5426.

F. HEAT SHIELD

000-403-(34, 45, 54, 57 or 72)

The high quality, stainless steel Heat Shield, available for all Mt. St. Helens models, serves as a heat guard and backsplash to protect a wall at the rear of the charbroiler, adding 20" to the height of the charbroiler.

Note: When the optional Okanogan Single-Spit Rotisserie, which has its own rear shroud, is installed on the Mt. St. Helens Charbroiler, this Heat Shield is not compatible.

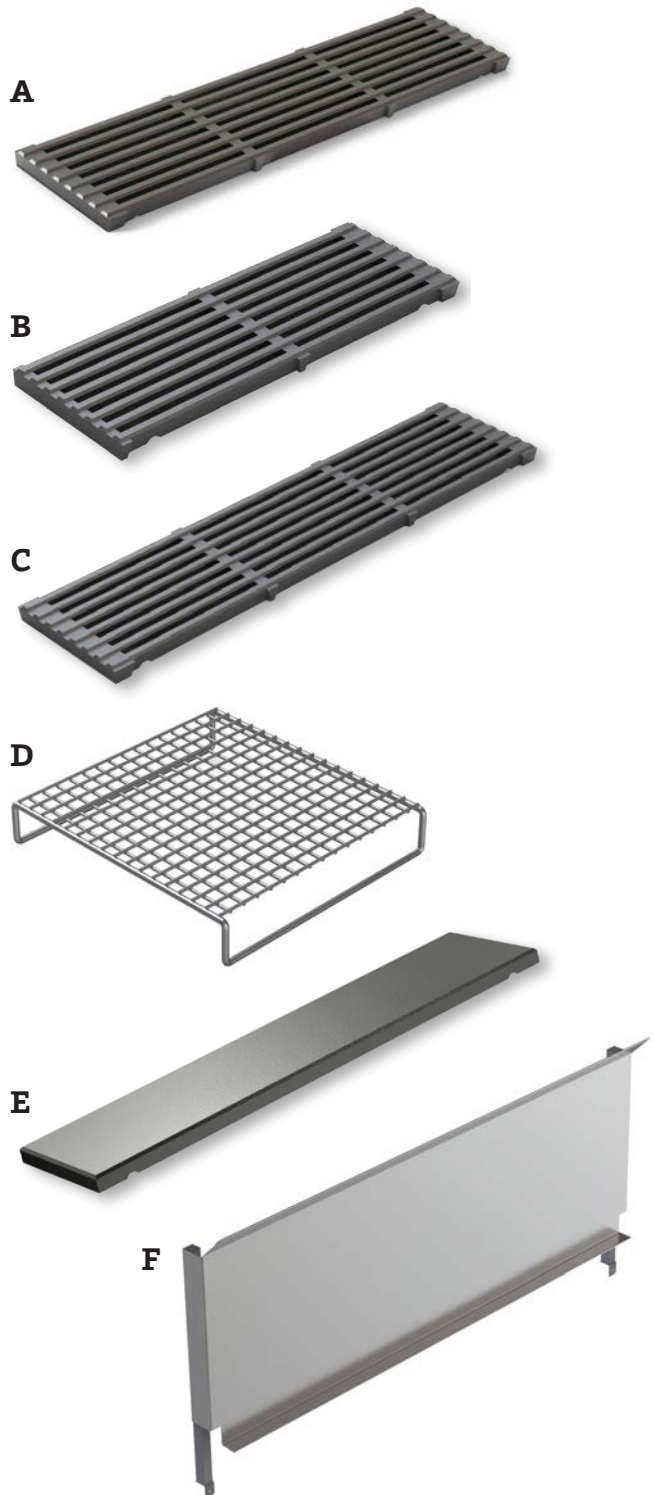

t. 360.650.1111
tf. 800.988.8103
f. 360.650.1166

Wood Stone Corporation
1801 W. Bakerview Rd.
Bellingham, WA 98226 USA
info@woodstone-corp.com
woodstone-corp.com

REVISED: SPRING 2017

An ongoing program of product improvement may require us to change specifications without notice.



A. STANDARD ANGLE SPIT 000-307

The Standard Angle Spit is included with all Wood Stone rotisseries. Six to seven average-sized birds can be quickly loaded. The perforations are convenient for securing the string or skewers used to bind the legs.



B. SQUARE SPIT WITH ADJUSTABLE FORKS 000-306

The Square Spit With Adjustable Forks is made of half-inch square stock stainless steel and comes with 5 double forks and two single forks. It is easy to load and the forks hold the birds in place so that no binding of the legs is required. This spit holds from 1 to 6 birds of various sizes.

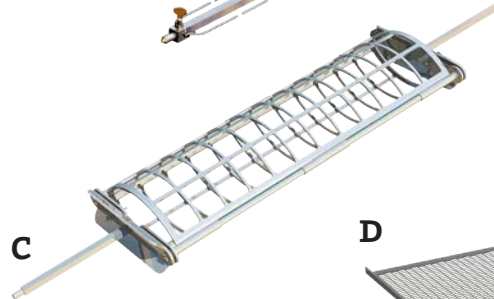

C. CLAMSHELL BASKET 000-300

The versatile Clamshell Basket spit is constructed of heavy gauge stainless steel and conveniently adjusts to hold a variety of products, ranging from fresh vegetables to two entire prime ribs. Stainless steel screens are also available to help secure smaller items. Includes Chain Assembly For Clamshell Basket locking mechanism.

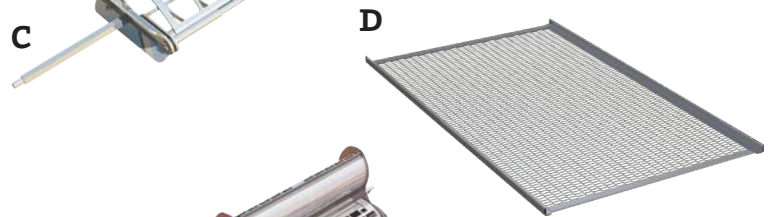

D. FISH AND VEGETABLE SCREEN 000-305

The 26 x 16" Fish And Vegetable Screen inserted into the Clamshell Basket compartment expands the versatility of the spit.

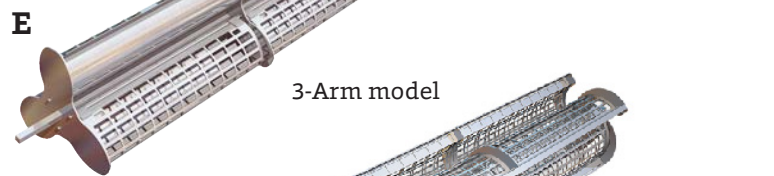

E. RIB/FISH BASKET SPIT

The Rib/Fish Basket Spit is available in a 3-arm, 6 compartment, or in a 4-arm, 8 compartment model. On the 4-arm spit, each compartment is suitable for a full rack of ribs, a sizeable salmon fillet or several smaller cuts of meat. On the 3-arm spit, the size of each compartment makes it ideal for larger items such as tri-tip roasts and pork loins. The laser-cut containment flap is spring-loaded for easy loading and unloading.

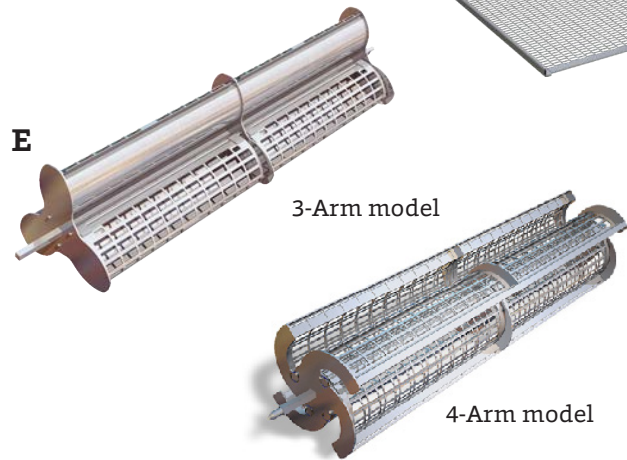

000-311-(R, L) 3-arm, 6 compartment

000-303-(4R, 4L) 4-arm, 8 compartment

F. FISH AND VEGETABLE SCREEN 000-315

The 18 x 6" Fish And Vegetable Screen inserted into the 4-arm version of the Rib/Fish Basket Spit expands the versatility of the spit.

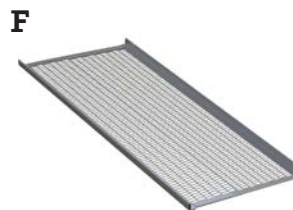

REVISED: SPRING 2017, r01

An ongoing program of product improvement may require us to change specifications without notice.

t. 360.650.1111
tf. 800.988.8103
f. 360.650.1166

Wood Stone Corporation
1801 W. Bakerview Rd.
Bellingham, WA 98226 USA
info@woodstone-corp.com
woodstone-corp.com





G. PIG SPIT ASSEMBLY 000-319-PIG

The Pig Spit Assembly features a spit made from half-inch square stainless steel stock, stainless steel end forks and an aluminum back brace. The assembly is suitable for roasting a 30–40 lb suckling pig or lamb.

H. MULTI-SKEWER DRUM ASSEMBLY

000-304-4-(34, 45 or 57)

The Multi-Skewer Drum Assembly is for use with the Okanogan Single-Spit Rotisserie. Available in 34", 45" and 57" widths. The assembly increases the capacity of 45" and 57" rotisseries from 3–4 chickens to 12–16 chickens at a time, turning the single-spit rotisserie into a powerful production unit. Increased capacity of the 34" model is from 2 chickens to 6–8 chickens.

I. SPIT CART 000-CAS-CART

This compact Spit Cart features a sturdy stainless steel body specifically designed to hold rotisserie spits upright, facilitating loading and storage. The cart measures 18 x 26.75", with a 40.25" overall height.

J. GFR SMOKER TRAY 000-314

The Smoker Tray is a perforated stainless steel box for use with the GFR gas-fired rotisserie to help influence flavor. It accommodates approximately 3.5 lbs of well soaked wood pieces and partially-ignited charcoal to create smoke. Wood and charcoal can be replenished during the cook cycle to maintain smoke.



t. 360.650.1111
 tf. 800.988.8103
 f. 360.650.1166

Wood Stone Corporation
 1801 W. Bakerview Rd.
 Bellingham, WA 98226 USA
info@woodstone-corp.com
woodstone-corp.com

REVISED: SPRING 2017, r01

An ongoing program of product improvement may require us to change specifications without notice.



K. SPIT FORKS SINGLE 000-301-S

A stainless steel, single direction two-prong Spit Fork, used for holding smaller product, such as chicken, in place on a Square Spit. For use with SFR, GFR and SSR rotisseries.

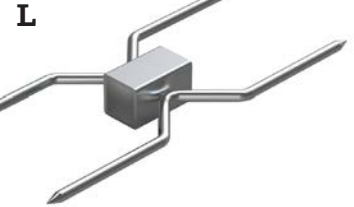

L. SPIT FORKS DOUBLE 000-301-D

A stainless steel, double direction four-prong Spit Fork, used for holding smaller product, such as chicken, in place on a Square Spit. For use with SFR, GFR and SSR rotisseries.

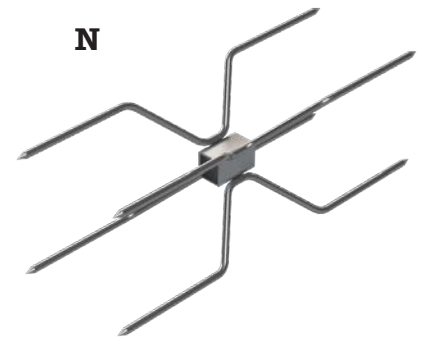
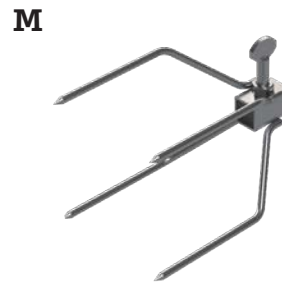

M LARGE FORKS SINGLE 000-319-LG-S

A stainless steel, single direction four-prong Spit Fork, used for holding larger product, such as turkey, in place on a Square Spit. For use with SFR, GFR and SSR rotisseries.

N. LARGE FORKS DOUBLE 000-319-LG-D

A stainless steel, double direction eight-prong Spit Fork, used for holding larger product, such as turkey, in place on a Square Spit. For use with SFR, GFR and SSR rotisseries.

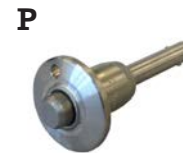

O. CHAIN ASSEMBLY FOR CLAMSHELL BASKET 000-302

Replacement locking mechanism for the Clamshell Basket.

P. PUSH RELEASE BASKET PIN 50RO-0001

Replacement locking pin on the Chain Assembly For Clamshell Basket.

Q. STANDARD BROILER GRATE 50RO-0017

Replacement 6 x 24" Standard Broiler Grate for all Mt. Olympus Rotisseries with Optional Charbroiler. See table below for quantities.



Model	6 x 24" Grates
SFR-(6, 10)	7
SFR-(6, 10)-N	5

t. 360.650.1111
tf. 800.988.8103
f. 360.650.1166

Wood Stone Corporation
1801 W. Bakerview Rd.
Bellingham, WA 98226 USA
info@woodstone-corp.com
woodstone-corp.com

REVISED: SPRING 2017, r01

An ongoing program of product improvement may require us to change specifications without notice.





CHICKEN ACCESSORIES

A. CHICKEN BELL CHOIR 000-318-CBELL-CHOIR

A choir of 3 stainless steel "bells" for cooking 3 chickens on the Whatcom Gas Vertical Rotisserie (GVR). Includes one Chicken Top Bell and two standard Chicken Bells.

B. CHICKEN BELL 000-318-BELL

Replacement standard Chicken Bell for cooking chickens on the Whatcom GVR. Must hang below a Top Bell.

C. CHICKEN TOP BELL 000-318-TPBELL-C

Replacement Chicken Top Bell for cooking chickens on the Whatcom GVR. Includes "S" hook for attachment to the rotisserie and can be used to hang two more standard Chicken Bells to complete a "choir".

Note: Wood Stone recommends using chickens between 3 and 5 lbs. for optimum performance in this rotisserie.

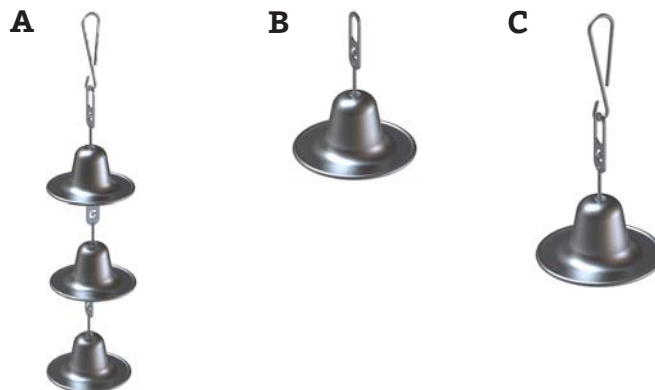

TURKEY ACCESSORIES

D. TURKEY BELL CHOIR 000-318-TBELL-CHOIR

A choir of 2 stainless steel bells for cooking 2 turkeys on the Whatcom GVR. Includes one Top Turkey Bell and one standard Turkey Bell.

E. TURKEY BELL 000-318-BELL-T

Replacement standard Turkey Bell for cooking turkeys on the Whatcom GVR. Must hang below a Turkey Top Bell.

F. TURKEY TOP BELL 000-318-TPBELL-T

Replacement Turkey Top Bell for cooking turkeys on the Whatcom GVR. Includes "S" Hook for attachment to the rotisserie and can be used to hang one more standard Turkey Bell to complete a "choir".

Note: Wood Stone recommends using 7-10 lb. turkeys for optimum performance in this rotisserie.

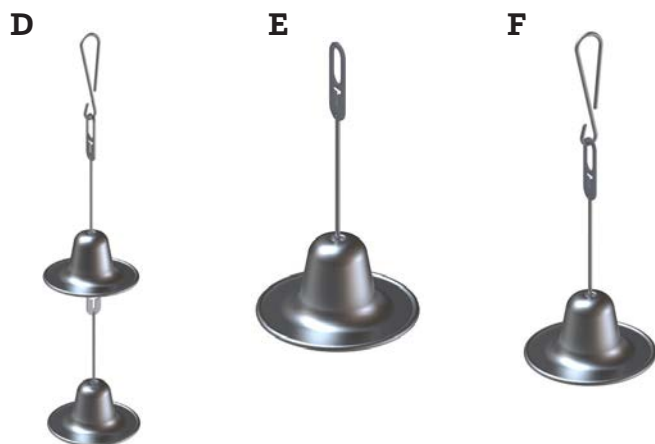

G. REPLACEMENT HOOK 000-318-HOOK

Stainless steel "S" Replacement Hook for hanging accessories.

H. KEEPER CLIP 000-318-CLIP

Replacement clip for Whatcom GVR and Tandoor skewers, keeping product from falling off the end of a skewer.

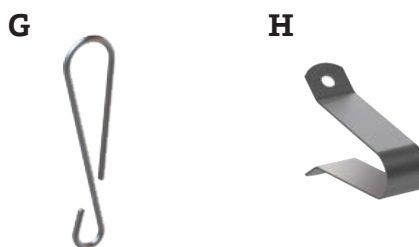

t. 360.650.1111
tf. 800.988.8103
f. 360.650.1166

Wood Stone Corporation
1801 W. Bakerview Rd.
Bellingham, WA 98226 USA
info@woodstone-corp.com
woodstone-corp.com

REVISED: SPRING 2017

An ongoing program of product improvement may require us to change specifications without notice.



I. DUCK HOOK WS-TL-DO-DH

A two-prong, 6" Duck Hook, for use with the Duck Oven or Whatcom GVR, this hook system allows for the easy hanging of Peking duck, other fowl, or roasts needing more than one attachment point for balance.

J. THREE-PRONGED RIB HOOK 000-318-PRONG

Three-Pronged Rib Hook with the following capacities: Baby Back Ribs: Avg. weight 1.5 lbs., St. Louis Ribs: 2 lbs., Salmon Fillet: Up to 3 lbs.

K. SKEWER 000-318-SKEWER

The Skewer rod is 23" long, and can hold product of 2.25" maximum radius (center to outside measurement) to utilize all ten hooks; 4.5" maximum radius to utilize 5 hooks. Includes "S" Hook, Keeper Clip and Skewer rod.

L. CHURRASCO SKEWER 000-318-CHURRASCO-2

The thicker stainless steel Churrasco Skewer for larger proteins and vegetables up to 19.5" in length, including whole fish up to 8 lbs. Will hold 2 roasts up to 12 lbs. each. Prongs are 2". Excellent for tableside presentation.

M. LARGE ADJUSTABLE BASKET 000-318-BASKET-LG

000-318-BASKET-LG

The Large Adjustable Basket is great for prime rib, pork loin, rack of pork, or any roast larger than 3" but less than 6.5" in diameter and up to 20 inches long.

N. SMALL ADJUSTABLE BASKET 000-318-BASKET-SM

000-318-BASKET-SM

The Small Adjustable Basket is great for those who do not wish to skewer their food. Perfect for rack of lamb, tenderloins, small roasts and quail. The basket holds multiple products 3" in diameter and up to 20" long.

O. ADJUSTABLE FISH BASKET 000-318-BASKET-FISH

000-318-BASKET-FISH

The Adjustable Fish Basket is designed for fish fillets up to 15.5" long, 3" wide and 1.5" thick, weighing up to 3 lbs. Also great for unusually shaped roasts like beef tri-tip.

P. ADJUSTABLE BASKET RETENTION ROD 000-318-BSKT-ROD

000-318-BSKT-ROD

Replacement rod for Large and Small Adjustable Baskets.

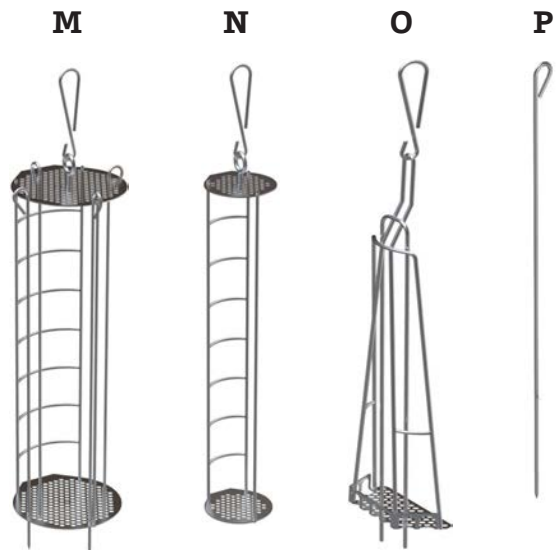
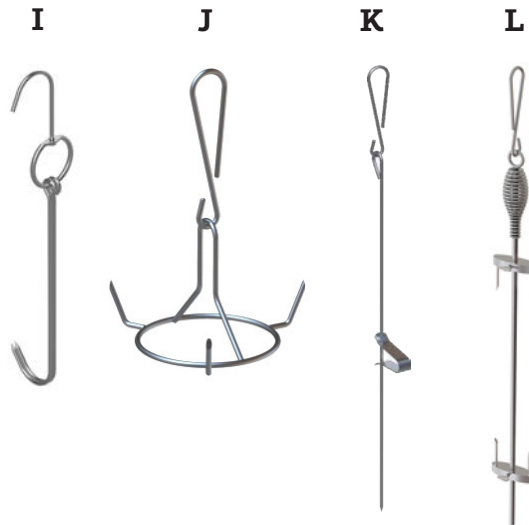

t. 360.650.1111
tf. 800.988.8103
f. 360.650.1166

Wood Stone Corporation
1801 W. Bakerview Rd.
Bellingham, WA 98226 USA
info@woodstone-corp.com
woodstone-corp.com

REVISED: SPRING 2017

An ongoing program of product improvement may require us to change specifications without notice.





Q. UTENSIL RACK 000-318-UTRACK

The Whatcom GVR Utensil Rack slides onto any sheet pan cart shelf (not included). The rack features hooks on which to hang raw or cooked product using any of the accessories shown.

R. GVR SMOKER TRAY 000-318-SMOKETRAY

Stainless steel, two compartment GVR Smoker Tray for the Whatcom GVR. As it sits on the floor of the gas-fired rotisserie, the smoker tray acts as a flavor enhancer as well as imparting the distinctive aroma of a wood-fire.

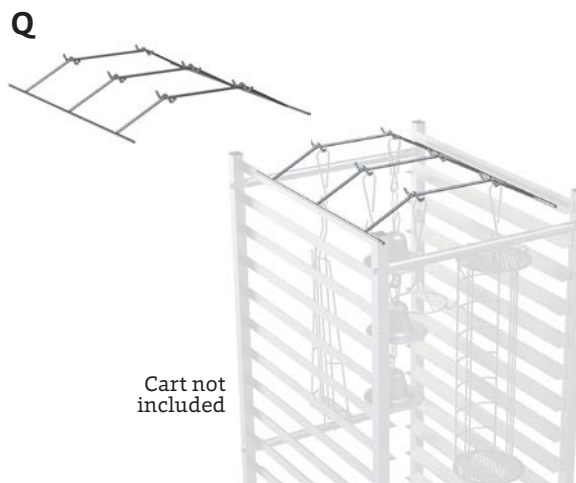

t. 360.650.1111
tf. 800.988.8103
f. 360.650.1166

Wood Stone Corporation
1801 W. Bakerview Rd.
Bellingham, WA 98226 USA
info@woodstone-corp.com
woodstone-corp.com

REVISED: SPRING 2017

An ongoing program of product improvement may require us to change specifications without notice.



WOOD-FIRED

A. MINI-LIGNO E WOOD MOISTURE METER WS-TL-MM

Wood Stone's Mini-Ligno E Wood Moisture Meter instantly measures the moisture content of any type of wood, ensuring proper moisture content. Press the probes into the wood surface and the meter quickly displays the moisture percentage on the easy-to-read scale, ranging from 6–36%. An extra (longer) set of probes is included. The meter uses one 9V battery, good for 5,000 readings. The meter and the cap are built of high-impact plastic for years of use. The pocket-sized meter measures only 6 x 3 x 1" and weighs 6 ounces.

B. FIRE HORSE 000-FIREHORSE

The Wood Stone stainless steel Fire Horse can help make your wood fire more efficient. The Fire Horse props up the logs, elevating them off the floor to allow more air to feed the fire.

WOOD- OR COAL-FIRED

C. PARTICLE SHOVEL WS-TL-PS-(S, M, L or XL)

Our heavy gauge stainless steel Particle Shovel is designed to safely remove ash and coals from wood-fired ovens and charbroilers. Its front is beveled to remove ash from even hard-to-reach corners. See page 5 for lengths.

COAL-FIRED

D. COAL OVEN RAKE

The triangular hoe-style Coal Oven Rake is useful in coal-fired ovens for manipulating coal inside the oven chamber, as well as scraping debris and fly ash through the coal grates and into the ash chute. Available in two lengths:

WS-TL-CR-M Medium Handle, 63"

WS-TL-CR-XL Extra Long Handle, 84"

E. ASH CHUTE TOOL WS-TL-ACT-M

The 63" stainless steel Ash Chute Tool is useful for removing ash and small coal fragments from the ash chute on coal-fired ovens.

A



B



C



D



E



REVISED: SPRING 2017

An ongoing program of product improvement may require us to change specifications without notice.

t. 360.650.1111
tf. 800.988.8103
f. 360.650.1166

Wood Stone Corporation
1801 W. Bakerview Rd.
Bellingham, WA 98226 USA
info@woodstone-corp.com
woodstone-corp.com



F. COAL GRATES RP-GRATE-CL-SET

Two replacement Coal Grates, sold as a set, for Fire Deck Series coal ovens. Both 15.75" x 7.75" grates must be replaced at the same time.



G. DOUBLE COMPARTMENT ASH DOLLY WS-TL-AD

The Wood Stone Double Compartment Ash Dolly is an efficient and safe means to store and transport the ash that needs to be removed from the oven each morning. It has two compartment sleeves for ash storage. After the first sleeve has been filled, the second sleeve should be filled. By the time the second sleeve has been filled, the first will have had time to cool and should be safe to dump. By separating the ash into two compartments, it is easier to control the disposal of leftover ash in a safe manner.

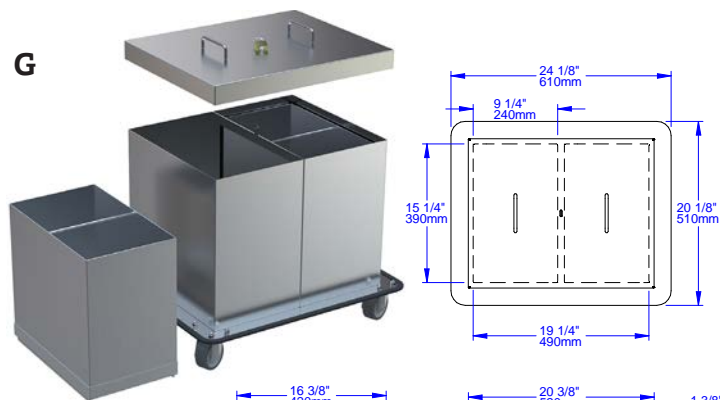

Caution is necessary to prevent any live coals mixed in with the ash from being dumped into an area or container with combustibles. Retain ashes in the closed container until all the cinders have thoroughly cooled. Ashes can then be disposed of safely.

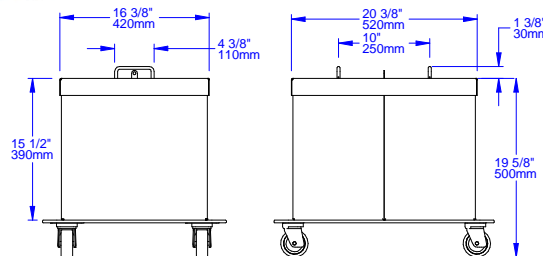

The unit comes with a lock eye and a brass security lock with two keys. The unit is made of 16-gauge stainless steel with a non-marking perimeter bumper edge. It has four non-marking, fully revolving low profile casters.

H. WOOD HANDLING CART WS-TL-WHC

Wood Stone's stainless steel Wood Handling Cart is designed to address the day-to-day issue of transporting fuel from the main wood storage area to the solid fuel appliance. The 6.5-cubic-foot capacity cart is constructed from 14-gauge stainless steel. The cart is designed to hold 18-inch logs and to contain the accompanying bark chips and sawdust. It rolls easily over thresholds and carpeting on durable, 3 x 7/8", fully revolving, non-marking casters. This piece is built for a lifetime of reliable use.

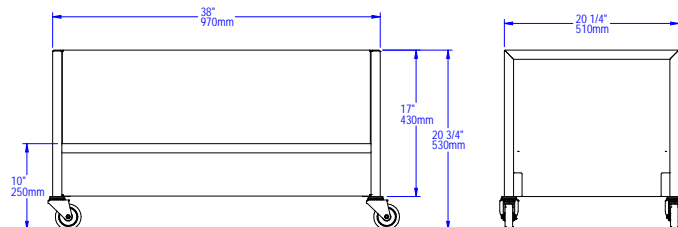

t. 360.650.1111
tf. 800.988.8103
f. 360.650.1166

Wood Stone Corporation
1801 W. Bakerview Rd.
Bellingham, WA 98226 USA
info@woodstone-corp.com
woodstone-corp.com

REVISED: SPRING 2017

An ongoing program of product improvement may require us to change specifications without notice.

NOTES



Quality

The perfect blend of high tech, high touch, and innovation.

From the initial design phase to the finished product, we are inspired to create and build high performance foodservice equipment that performs dependably over a lifetime.



Trusted

Offering support and guidance before and after the sale.

Answering your initial questions, sharing our combined experience, welcoming you to our Test Kitchen, and providing industry-leading 24-hour service support. You're family when you choose Wood Stone.



Worldwide

More than 15,000 installations in 80+ countries worldwide.

Our loyal and committed customers, ranging from California Pizza Kitchen to independent restaurants worldwide, have chosen Wood Stone since 1990.



Invested

Wood Stone Corporation is employee-owned (ESOP).

When you call Wood Stone, you're talking to an owner. We all work together to guarantee we're meeting our commitment to you, both now, and over the life of your equipment.

Wood Stone

Spring 2017

Wood Stone Corporation
1801 W. Bakerview Rd.
Bellingham, WA 98226 USA

t. 360.650.1111
tf. 800.988.8103
f. 360.650.1166

info@woodstone-corp.com
woodstone-corp.com

version
3.0